



A.D. METALNA INDUSTRIJA VRANJE
Radnička br: 1

PELLET BOILER GRANDE



INSTRUCTIONS FOR USE, MAINTENANCE AND INSTALLATION



This product meets the requirements of the Ecodesign Directive in terms of efficiency and air pollution level, in order to contribute to the reduction of energy consumption and negative environmental impact.

DEAR CUSTOMERS !!!

Thank you for purchasing the GRANDE Boiler. Please read this user guide completely and carefully before you install and start using your GRANDE Pellet Boiler.

The heating units (hereinafter referred to as "pellet boilers" or "boilers") of Alfa Plam a.d. company have been designed, manufactured and tested in accordance with the requirements of the applicable European Directives on safety standards.

These instructions are intended for end users, installers and technicians certified for operations on GRANDE Pellet Boilers. If you have any questions regarding the instructions or need an explanation, please directly contact the manufacturer or an Alfa Plam authorized dealer.

Printing, translation or reproduction of the user guide, even partially, is only possible with the written permission of the Alfa Plam company.

You have purchased the GRANDE boiler, which is used for central heating of the area from 80 to 204m². The boiler uses pellets as fuel. It operates automatically and uses a screw conveyor for dosing the pellets from the pellet tank, which is part of the device placed above the boiler part of the plant. Fuel pellets are filled from above through the lid to be used for that purpose. Make sure that the boiler is properly dimensioned with respect to the heating system and energy requirements of the facility. Connection and commissioning of the unit should be done by a person authorized by the Alfa Plam company.

The flame that develops in the boiler during normal combustion of wood biomass releases just the right amount of carbon dioxide (CO₂) that would be released by natural decomposition of the wood. The amount of CO₂ formed during combustion or decomposition of the wood corresponds to the amount absorbed by the tree during its life cycle and turned into oxygen and carbon. By the use of non-renewable energy sources (coal, fuel oil, gas), unlike those energy sources that are based on wood, much larger amounts of CO₂ are released in the air. Carbon dioxide builds up during the years and contributes to enhancing the greenhouse effect. The principle of clean combustion meets all the requirements of preserving the environment, and the Alfa Plam company has directed all its development and its activities in the direction of fulfilling this goal.



- The minimum installed power of the heating system must not be less than 65% of the boiler's rated power, and the maximum power of the system must not exceed 100% of the boiler's rated power.
- The flue connected to the boiler must meet the requirements set in the user manual.
- To connect the appliance to the flue, do not use flexible hoses instead of flue pipes.
- Regular maintenance and care, such as cleaning the boiler, flue pipes and nozzles (pipes), are important for safe operation, and especially for effectiveness and maintenance value of the boiler.
- Do not perform any unauthorized modification to the appliance, as any unauthorized modification will void the warranty.

Contents:

1.	THE PURPOSE OF THE USER GUIDE	1
2.	RESPONSIBILITY OF THE MANUFACTURER	1
2.1.	MAIN USER RESPONSIBILITIES	1
2.2.	REQUIRED GENERAL STANDARDS	1
2.3.	HARMONIZED STANDARDS	1
2.4.	TRANSPORT AND MOVEMENT OF PELLET BOILERS	1
2.5.	RESPONSIBILITY OF THE INSTALLER	2
3.	INSTALLATION	2
3.1.	SETTING UP	2
3.2.	THE FLUE GAS EXHAUST SYSTEM	3
3.3.	AIR SUPPLY	6
3.4.	CONNECTION TO THE POWER SUPPLY	7
4.	NON-RETURN VALVE	7
4.1.	MIXING VALVE	8
5.	BOILER FIRST STARTING	8
6.	SAFETY WARNINGS	8
6.1.	SAFETY WARNINGS FOR SERVICE PERSONNEL	8
6.2.	SAFETY WARNINGS FOR USERS	9
7.	INSTRUCTIONS FOR BOILER SAFE STARTING AND SAFE CLEANING	9
7.1.	ROUTINE MAINTENANCE AND CLEANING	9
7.2.	INSPECTION AND PARTS THAT NEED TO BE MAINTAINED	10
7.3.	ADDITIONAL MAINTENANCE	11
8.	IMPORTANT SAFETY INFORMATION	11
9.	PELLET QUALITY IS VERY IMPORTANT	11
9.1.	PELLET STORAGE	11
10.	BOILER CONTROL SYSTEM	12
10.1.	Electrical connection diagram	12
10.2.	Control panel (display) – keys and functions	13
10.3.	Menu	14
10.3.1	Combustion Management Menu	15
10.3.2	Heating Management Menu	16
10.3.3	Chrono Menu	17
10.3.4	Load Menu	18
10.3.5	Time and Date Menu	18
10.3.6	Remote Control Menu	18
10.3.7	Language Selection Menu	18
10.3.8	Keyboard Menu	18
10.3.9	System Menu	19
10.4.	Ignition of the boiler and Ignition Phases	19
10.5.	Possible problems and solutions	20
11.	INFORMATION ON THE DISPOSAL AND STORAGE OF THE BOILER	21
12.	TECHNICAL CHARACTERISTICS OF THE GRANDE - PELLET BOILER	22
13.	DIMENSIONS OF BOILER - GRANDE	23
14.	Scheme of hydraulic installation of pellet boiler – GRANDE	23
14.1.	Pellet boiler hydraulic installation diagram (radiator heating)	23
14.2.	Pellet boiler hydraulic installation diagram (radiator and floor heating)	24
14.3.	Pellet boiler hydraulic installation diagram (accumulation tank)	24

1. THE PURPOSE OF THE USER GUIDE

The purpose of this User Guide is to invite the user to take all necessary safety precautions and provide all the necessary actions that will guarantee proper and safe use of the heating appliance.

AMENDMENTS

This User Guide takes into account all the advanced technology that existed at the time of launching the pellet boilers on the market.

It shall not apply to the products already on the market, accompanied by appropriate technical documentation, and cannot be considered incomplete or inadequate after each change, adaptation or application of new technologies on newer products.

The contents of this booklet should be carefully read and studied. Any information presented in this booklet should be considered necessary for the proper installation, use and maintenance of your boiler.

Instructions should be carefully stored in a safe place. Instructions for use, maintenance and installation shall be considered an integral part of the pellet boilers.

If the boiler is sold to a third owner, care should be taken to deliver this User Guide together with the boiler.

If the instructions happen to get lost, you can request a new copy from the manufacturer or an authorized dealer.

2. RESPONSIBILITY OF THE MANUFACTURER

By the delivery of this User Guide the Alfa Plam company a.d. disclaims any criminal or penal liability for direct or indirect causing of:

- and /or damage that occurred due to non-compliance with standards or notes contained in this User Guide; accidents
- accidents and /or damage that occurred due to improper or incorrect use by the user;
- accidents and /or damage due to modification or maintenance without authorization from the manufacturer Alfa Plam a.d.;
- accidents and /or damage caused by the use of non-original or inappropriate spare parts. Installing is the sole responsibility of the installer.

2.1. MAIN USER RESPONSIBILITIES

The boiler user must be an adult and responsible person.

Make sure that children do not approach the boiler while in operation, with the intention of playing.

Children must not approach the boiler while in operation with the intention of playing. This appliance can be used by children aged 8 and older and persons with reduced physical, sensory or mental abilities, if they are supervised by an adult who is familiar with the instructions for use. Boiler cleaning and maintenance cannot be performed by children without the supervision of an adult.

2.2. REQUIRED GENERAL STANDARDS

The GRANDE product is manufactured in accordance with the following standards:

MACHINERY DIRECTIVE (2006/42/EZ)

DIRECTIVE ON LOW VOLTAGE ELECTRICAL EQUIPMENT (2006/95/EZ)

ELECTROMAGNETIC COMPATIBILITY DIRECTIVE (2004/108/EZ)

DIRECTIVE FOR SOLID FUEL HEATING BOILERS TO THE NOMINAL POWER OF 500 kW (EN 303-5)

2.3. HARMONIZED STANDARDS

- SIST EN ISO 12100-1: 2004 and A1: 2010;
- SIST EN ISO 12100-2: 2004 and A1: 2010;
- SIST EN 303-5: 2012;
- 61000-6-3: 2007;
- 61000-6-2: 2005;
- 61000-3-3: A1 2002;
- 61000-3-3: A2 2006;
- EN 60204-1: 2006 and A1: 2009

2.4. TRANSPORT AND MOVEMENT OF PELLET BOILERS

Take care of your own safety when moving the boiler.

Prior to transport and movement of the pellet boiler, which should be done with maximum safety precautions, make sure that the load capacity of the cart is large enough to lift the boiler. Avoid sudden movements and/or improvised ways of moving the boiler. Handling of the boiler in terms of lifting, shifting and moving from one place to another can be done by the means of rod-shaped carriers threaded on one end. These rod-shaped carriers (4 pieces) are screwed on points provided for that on either side of the boiler (Fig. 1). Four men are required for this operation. **Boiler brackets are delivered with the boiler!**

Threaded rods



Figure 1. Handling the boiler using the bracket

▲ CAUTION

GATHER ALL PACKAGING MATERIAL AND KEEP IT AWAY FROM THE REACH OF CHILDREN. PARTS OF PACKAGING MATERIAL (BAGS, FOILS, STYRENE) POSE A CHOKING HAZARD.

2.5. RESPONSIBILITY OF THE INSTALLER

The responsibility of the installer is to verify the correctness of installation, air supply and all the conditions that are required for the installation of pellet boilers.

The responsibility of the installer is to verify compliance with legal regulations in the place where the boiler is installed. The pellet boiler must be used in accordance with the instructions for use, maintenance and installation, and with respect to the safety standards prescribed by the regulations in force at the place where the boiler is installed. Obligations of the installer are defined by the UNI Standard 10683. Installers should check:

- the type of device to be installed,
- the convenience of the installation of the device, i.e. the minimum size of the space in which the pellet boiler is intended to be installed,
- compliance with regulations concerning draining the flue gases, as identified in the instructions provided by the manufacturer of the heating plants,
- the inner diameter of the chimney, the material from which it is made, whether it is straight and correct, and whether it is free from clogging,
- height and possible vertical extension of the chimney,
- the existence and proper resistance of the chimney caps,
- the possibility of supply of the outside air,
- the possibility of concomitant use with other heat sources connected to the existing devices.

If the existence of the above indicated is established, the installation can begin. Follow with due attention the manufacturer's instructions, the current safety norms and standards for fire protection.

After the first start of the boiler, it is necessary to carry out trial operation of the unit for at least 30 minutes, in order to check whether all the required conditions are met.

Upon completion of the installation, the installer must submit the following documents to the buyer:

- operating, maintenance and installation instructions, supplied by the manufacturer (if not included as part of the boiler),
- documents required by the applicable regulations,
- should teach the client how to use the device, how to carry out routine maintenance and cleaning.

3. INSTALLATION

Responsibility for the installation works at the place where the boiler is installed rests solely with the purchaser. Before beginning the installation works, the installer should check whether all safety requirements are met, in particular:

- Check whether the regulations for the installation of pellet boilers meet local, national and European standards.
- Comply with all requirements stated in this document.
- Check that the pipes and lines for air supply correspond to the type of installation.
- Do not run a temporary electrical connection using inappropriate cables.
- Check grounding of electrical installations.
- Always use personal protective equipment and comply with all prescribed safety precautions.
- Always leave enough space for maintenance.
- Measure emission of flue gases after completion of the installation.

3.1. SETTING UP

It is advisable to remove packaging material of the pellet boiler exactly at the place where the boiler is to be installed.

If the adjacent walls and flooring are made of materials that are not heat-resistant, it is necessary to ensure adequate protection and use of non-combustible insulation material.

To protect the flooring from combustible materials, it is recommended to insert a metal plate that is 3 to 4 mm thick with the front side at least 30 cm greater than the depth of the boiler, under the boiler. The pellet boiler must be installed in accordance with the sketch, which defines the distance from the walls (**Figure 2**)

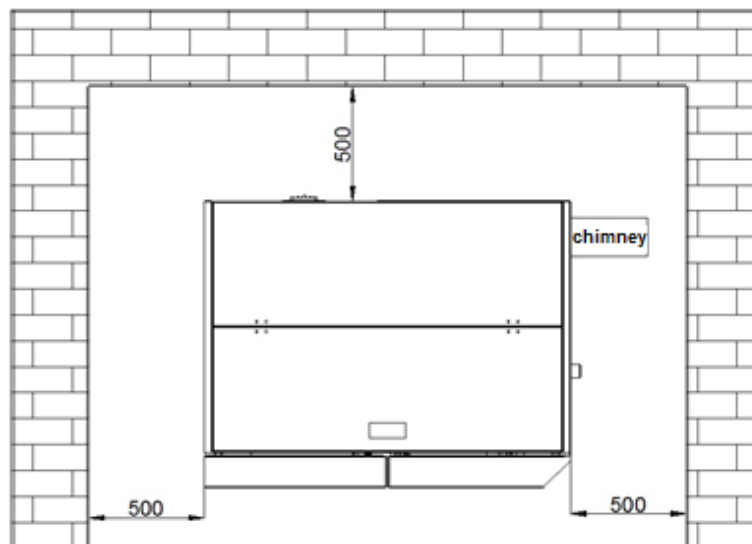

Figure 2. The minimum distance of the boiler from the walls

If the pellet boiler is installed in the boiler room where there are other devices that suck the air (other boilers, various types of suction fans, etc.), make sure that the volume of air entering the premise is sufficient to guarantee safe operation of the boiler.

If the chimney passes through the ceiling it must be sufficiently insulated with coating of non-flammable insulation material.

After the pellet boiler is set in place, level it (bring it to a horizontal position) with adjustable legs.

▲ CAUTION

The flue gas exhaust system **MUST NOT BE CONNECTED TO:**

- the uptake used by other heating devices (boilers, furnaces, fireplaces, etc.),
- the system for air extraction (from the hood, suction fan, etc.).

▲ CAUTION

It is prohibited to install barriers for the regulation of the flow of flue gases!

The connector of the Ø80 mm flue pipe from the pellet boiler to the chimney should have the following characteristics: total length of up to 5 m (in the case of the connector of greater length connecting pipes diameter should be increased to Ø130 mm),

- each elbow of 90° reduces the total length of the flue pipe by 1 m,
- cover intended for cleaning should be located on each elbow,
- pipe joints need to be sealed.

▲ CAUTION

In case the resistance in the exhaust system is too high (numerous elbows, inappropriate terminations, bottlenecks etc.), the flue gas exhaust is not guaranteed and it is necessary to increase the connecting pipes and elbows to greater dimensions, i.e. to Ø130 mm. Also, when the chimney does not provide proper flue gas exhaust, it may cause malfunction and consequently alarm activation in the GRANDE boiler. It is recommended that the chimney is inspected by a professional person before installation of the GRANDE Boiler.

The system for discharging flue gases from the boiler functions at the underpressure generated in the combustion chamber and the faint pressure in the Ø80 mm flue pipe. Therefore, care should be taken to provide complete tightness of the flue pipe.

It is necessary to carefully analyze the position and condition of the area through which the chimney passes. If the flue pipe passes through the wall and/or roof it should be suitably insulated in accordance with the safety regulations for fire protection.

Make sure that the room in which the pellet boiler is installed has a sufficient amount of air, which guarantees proper combustion. The air intake pipe should be of a minimum outer diameter of 110 mm and of a maximum length of 10 m. For every 90° elbow the maximum length is reduced by 1 m. If the length is too large, it is necessary to increase the diameter of the air supply pipes.

If the grating is placed on the façade, the area of the air inlet port must be at least 100 cm² or larger.

The device works on 220-230 V, 50 Hz voltage. Make sure that the cables for electrical connection do not pass under the boiler, that they are installed away from heated surfaces and that they do not come into contact with sharp objects that may damage them. If the pellet boiler is under increased electrical voltage, the durability of electrical components will be greatly reduced.

▲ CAUTION

Do not remove the plug from the socket in order to switch off the boiler until the flame in the boiler is extinguished.

3.2. THE FLUE GAS EXHAUST SYSTEM

The flue gas exhaust system shall be in accordance with the applicable regulations. Do not connect the flue pipe of the boiler to the chimney to which other furnaces are connected (**Figure 3**). The flue gas exhaust system must not end in a closed and/or in semi-enclosed areas, such as garages, narrow passageways, hallways, sub-corridors and the like. After connecting the boiler to the chimney, an authorized chimney sweep should check if there are any damages in the connection and whether the connection is properly sealed. If the chimney is not suitable it must be executed in accordance with the foregoing requirements (Section 3.1).

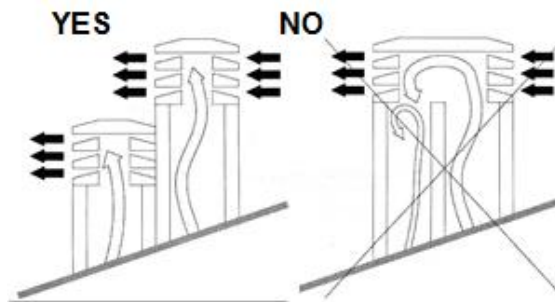

Figure 3

▲ CAUTION

An uptake should be grounded in accordance with the applicable regulations. (Grounding is legally defined and regulated.)

Grounding should be independent of the heating unit.

As far as dimensions and material are concerned, the flue pipe must meet the UNI 9615-9731, UNI 10683 – EN1856-1 standards.

Poorly preserved flue pipes or flue pipes made of inappropriate material (asbestos, galvanized sheet metal, porous materials) do not comply with applicable regulations and adversely affect the operation of the boiler.

Flue gases can be discharged via the conventional chimney (see figure below) if the following requirements have been met:

- Check if the chimney is maintained. For proper maintenance and/or restoration contact the chimney sweep.
- Flue gases can be discharged directly into the stack only if it is equipped with an inspection hole and if the chimney is not larger than 20 X 20 cm, i.e. if the diameter is not larger than 20 cm.
- If the chimney is larger, appropriately insulated stainless steel tube (of a corresponding diameter) should be inserted in it.
- Make sure that the chimney connection is properly sealed.
- Avoid contact with combustible material (ember) and in any case, install flame retardant insulation.

When fittings are used for connecting the pellet boiler to the chimney, elbows equipped with a cleaning hole shall always be installed (Figure 4). Using the elbow with a cleaning hole enables routine cleaning without the need for dismantling the pipe. Exhaust gases in the chimney connector are under slight pressure, thus it is necessary to make sure to check that the cover for ash cleaning is completely hermetically sealed and that it is closed tightly after each cleaning. Make sure that everything is properly put back in its place and check the condition of the seals.



Figure 4. Cleansing element

Pipes should be connected in such a way that their narrow connection element is always turned upward (Figure 4).

We recommend you do not make long horizontal sections of connection to the chimney. If there is no other possibility, pipes should not have a slope downward, but upward to at least 5%. The horizontal part should not be longer than 2 meters.

Direct connection of the boiler to the chimney with a straight pipe greater than 1 meter in length is not recommended.

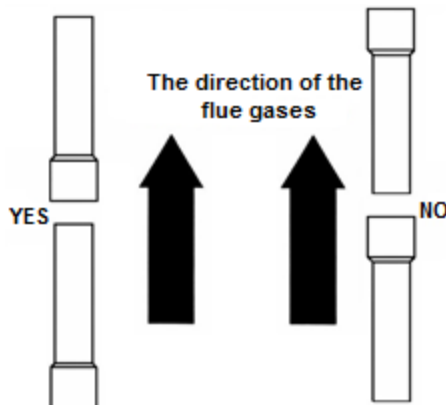

Figure 5.



Figure 6

Maximum allowed length of 80 mm diameter flue gas pipe to its point of entering the chimney is 6 m. After that the diameter of a flue gas pipe must be increased to 110 – 120 mm. In that case, each elbow accounts for 1 m length. For

example, if there are three bends of 80 mm diameter, the length of the flue gas pipes of 80 mm diameter is thus changed by 3 m. Just another 3 m of a straight pipe may be placed to the entrance of the chimney, in order to get 6 m length of the flue gas pipes of 80 mm diameter. After that, the bend must be enlarged, led back to flue gas pipes or should enter the chimney of a greater diameter, 110 – 120 mm.

Care should be taken not to use bends of a sharp angle of 90°. They must be of a certain radius or made in segments. Sharp angle bend increases resistance of the smoke flow through the bend.

- Each bend must be equipped with the cleaning door.
- Joints between the connection pipes must be tightened.
- For greater spacing, use 100 mm diameter connector. In that case, length of up to 8 m is allowed.

INSULATION AND DIAMETER OF ROOF OPENING

After you have determined the final position of the boiler, make an opening for the passage of the flue pipe. It depends on the method of installation, pipe diameter and type of walls or roof through which the flue pipe is run. Insulation should be done using mineral insulation material (glass wool) of nominal density greater than 80 kg/m³.

Ideal underpressure depends primarily on the lack of barrier contractions and/or angular connections. It is recommended the elbows be at 30°, 45° and 90°. The 90° elbows should be three-part elbows (Figure 7). In any case, it is necessary to ensure that the length of the initial vertical part of the flue pipe is at least 1.5 meters. Proper exhaust of flue gases is guaranteed in this way only.

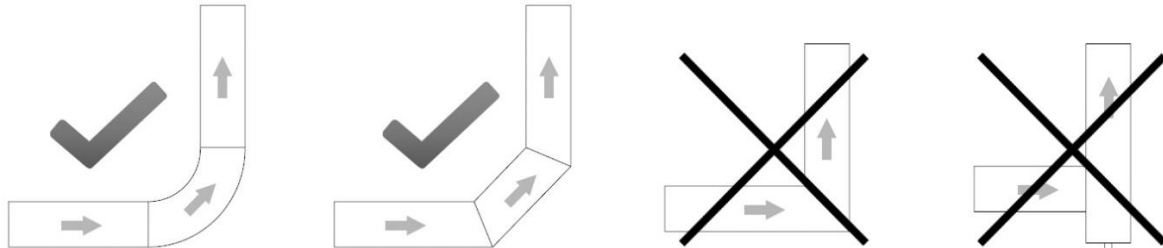
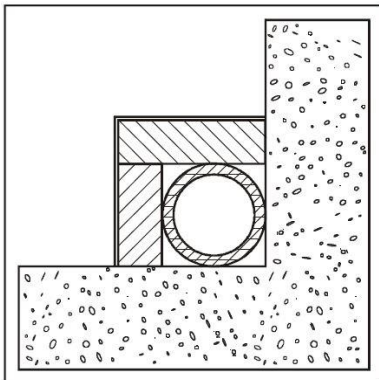
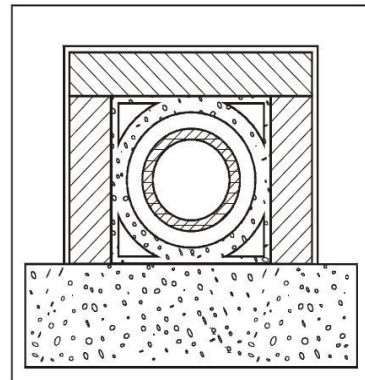

Figure 7.



AISI 316 steel flue with double insulated chamber, material resistant to 400 ° C. Optimal efficiency 100%



Waterproof flue with double insulated chamber and outer casing of light concrete. Optimal efficiency 100%

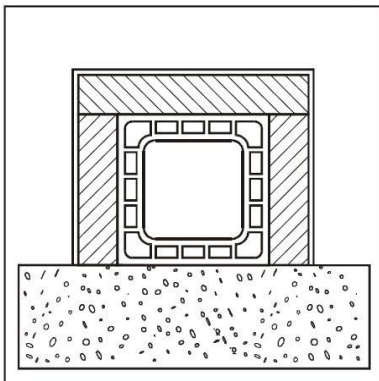

Traditional clay flue with indents. Optimal efficiency 80%

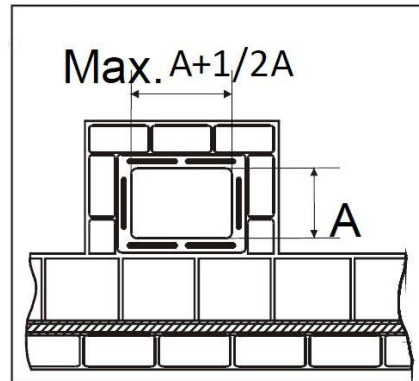

Do not use flue pipes with rectangular cross section with ratio different from the plan. Efficiency of modest 40%

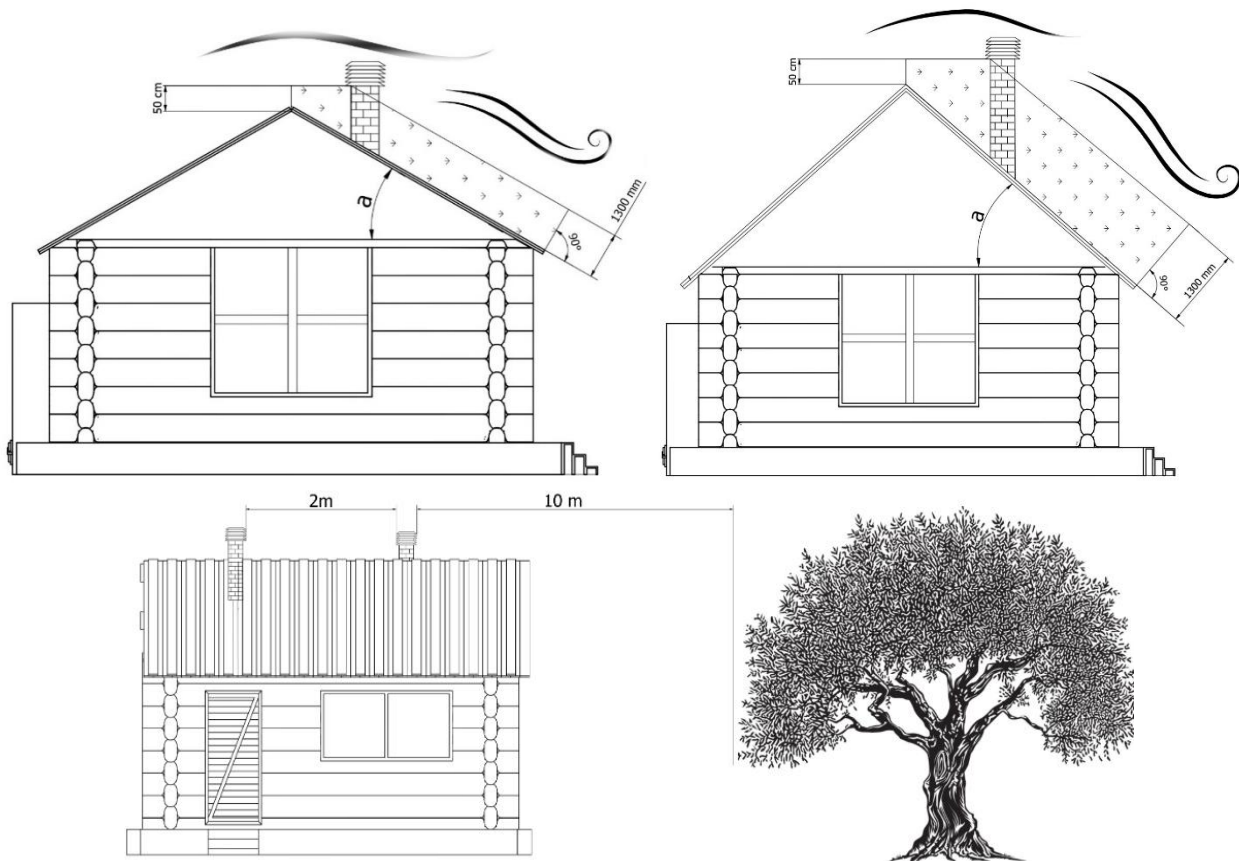

Flue – position and distance

3.3. AIR SUPPLY

The combustion air must be supplied to the room with the boiler. The room must be continuously aired.

The fresh air opening must be at the bottom of the room and must let in the air.

A) Combustion air supply by pipeline through basements. This connection option preheats the combustion air, which is useful for good and clean combustion. Installation of pipelines in the basement is simple.

B) Combustion air supply through basements. The combustion air is preheated. The basement space must be separated from the ventilation system of the house and open to the outside. Avoid high levels of dust and moisture.

V) Combustion air supply from above. Air supply from above can only be performed with tested flue systems. In this case, you must calculate the dimensioning of the flue!

D) Combustion air supply directly from outside. If the air is supplied directly through the outer wall, the combustion air is only slightly preheated, which is unfavorable for clean combustion. In this case, there is also a risk of condensation!

NOTE: We do not recommend these versions of the air supply! However, if you use these options, consult a qualified professional.

The room with the heating appliance must have a sufficient supply of fresh air. If the windows and doors are hermetically sealed or there are air extracting devices such as a hoods, hair dryers, fans, etc. located in the room with the boiler, combustion air (fresh air) must be supplied from outside. In any case, this should be discussed with the competent chimney sweeper before installing the boiler.

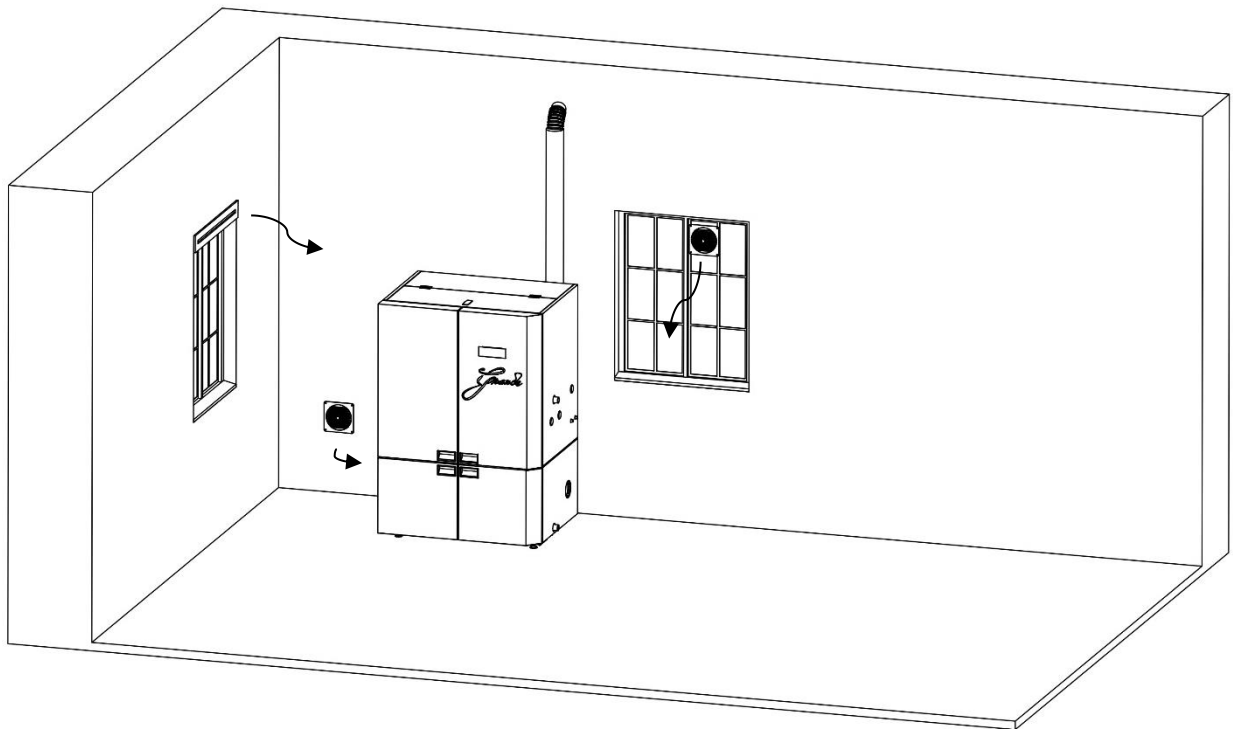

Figure 8- Fresh air supply to the room with the boiler

3.4. CONNECTION TO THE POWER SUPPLY

The device must be connected to the electricity grid. Our boilers are equipped with an electrical cable for medium temperature. If the power cord is damaged it must be replaced, so contact our authorized service. Before starting work on the electrical connection, care should be taken about the following:

- Make sure that the characteristics of electrical installations comply with data on the boiler.
- The flue gas exhaust system should be grounded in accordance with local regulations. (Grounding is required by law.)
- The power cord must not in any case be exposed to the ambient temperature of over 80°C. If you want to connect the boiler directly to the power grid, it is necessary to install a two-pole switch, suitable for the mains voltage in accordance with the applicable regulations, with contact spacing of at least 3 mm. The green-yellow earth conductor must be disconnected in the switch. The double pole switch must remain accessible after finishing the installation of the boiler.

Connecting to the power supply

The pellet boiler should be connected to the electricity grid. The electrical connection cable is 3 m long, white in colour and marked "220 V". Another connection cable is black, intended for connection of the circulation pump and marked "Pump".

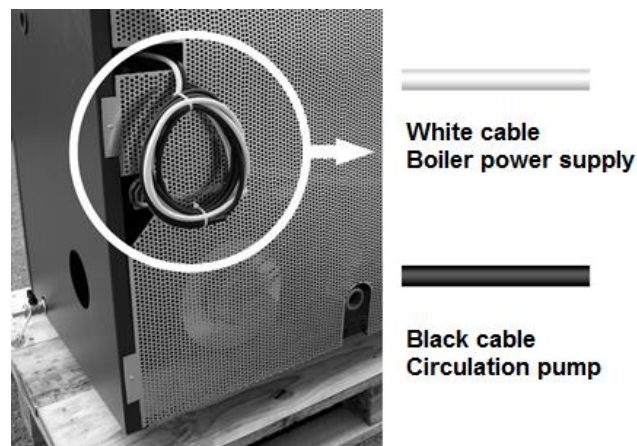

Figure 9.

White – boiler supply (220 V)

Black – circulation pump

If the power cord is damaged, replace it. Replacement must be done only by an authorized person. The power connector should remain available after the final installation of pellet boilers.

▲ CAUTION

After installing the boiler the measurement of emission of flue gases is required.

4. NON-RETURN VALVE

- Installation of a non-return valve in the hydraulic heating system is mandatory.
- The function of the non - return valve is to prevent cooling of the water in the boiler and condensation in the boiler and flue pipes. Condensation can occur as long as you do not spend 2 – 3 fuel tanks.
- Occurrence of condensation in the boiler is normal for the first ignition.

- The non – return valve is installed at the outlet of the pump, behind the pump, instead in front of the pump. Care must be taken about the direction of installation of the valve. Also, when purchasing, care must be taken of whether the valves are placed on horizontal, on vertical line, or as inclined, because there are valves that are installed only horizontally or only vertically, or that are universal.
- Ensure that the non – return valve can be opened easily (try by finger), so that it can be opened by the pump power.
- The non – return valve is placed behind each pump. If there are more pumps in the installation, then more non – return valves are needed.
- Connections to the boiler are 1". Non – return valves should also be 1", or larger.
- If the non – return valve is not installed, the guarantee will not apply!
- Diagram for installation of non – return valve:

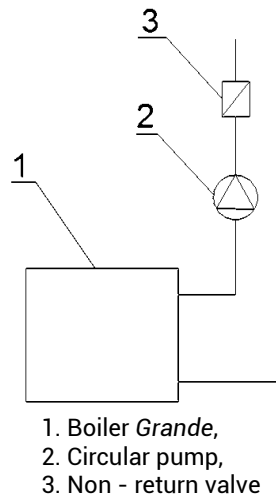

4.1. MIXING VALVE

- It is recommended that the hydraulic installation is fitted with a four – way mixing valve.
- For small installation a mixing valve is not required.
- For large installation a mixing valve is recommended.
- For underfloor heating installations a mixing valve is required. We recommend special thermostatic valves for underfloor heating, which regulate the temperature of the water entering the floor of up to 50°C. If there is no such a thermostatic mixing valve, temperature of water entering the flooring system must be regulated in some other way. It is the job of the designer and the installer.
- The mixing valve should be 1".

5. BOILER FIRST STARTING

The first starting of the boiler must be done only by an authorized person, otherwise the warranty becomes invalid.

INSTRUCTIONS FOR THE SAFETY OF PERSONS, ANIMALS OR PROPERTY

We want to draw attention of installers to some procedures to be followed so that proper installing of pellet boilers could be guaranteed. It is necessary to comply with the required standards, but they themselves are not sufficient. For more detailed information, it is necessary to read the rest of the instructions for use, maintenance and installation.

- Connect the pellet boiler to the power grid.
- Do not allow children or animals to approach the boiler.
- Only use pellet of guaranteed quality and do not use other fuels.
- Instruct all users of the possible risks and dangers and also inform them on how to manage pellet boilers.
- If the boiler is placed on a wooden floor, it should be insulated in an appropriate manner.

▲ CAUTION

The pellet boiler works in such a way that some underpressure is generated in the combustion chamber, so make sure that the flue gas uptake is heat proof.

At first starting (at least 1 hour of operation of the boiler) smelly paint fumes are released, so it is necessary to ventilate the room well.

6. SAFETY WARNINGS

6.1. SAFETY WARNINGS FOR SERVICE PERSONNEL

In addition to the general safety regulations, a person engaged in maintenance should respect the following:

- Always use safety equipment and personal protection devices as determined by the Directive 89/391/EZ.
- Make sure that the power supply is disconnected before beginning any activity.
- Always use the proper tool.
- Before beginning any intervention on the boiler, especially before coming into contact with the boiler make sure that the boiler and ashes in it are cold.
- **THE PELLETT BOILER IS CONSIDERED UNUSABLE EVEN IF ONLY ONE SAFETY DEVICE IS DEFECTIVE, IMPROPERLY REPAIRED OR IF IT IS NOT WORKING.**
- Do not make any modifications for any reason, except with the permission of the manufacturer or an authorized person.

- Always use only the original spare parts. Do not wait for the boiler parts to be worn out before replacing them. Replace the worn-out parts before they stop working completely, thus preventing the occurrence of damage due to sudden failure of the part, which may seriously endanger the safety of persons and /or your property.
- When cleaning the ashes, clean the firebox and the space beneath it.

6.2. SAFETY WARNINGS FOR USERS

The room in which a pellet boiler is or will be installed should be designed in accordance with local, national and European standards.

The pellet boiler is a combustion device. During operation, some parts may heat up to very high temperatures.

The pellet boiler is a class C1 designed to burn wood pellets (pellets with a 6 mm diameter, maximum 30 mm in length and of moisture content of up to 10%), i.e. C1 fuel (wood pellets) in accordance with the EN Standard 14961-2.

▲ CAUTION

WHILE THE BOILER IS IN OPERATION, CHILDREN MUST NOT APPROACH IT OR PLAY WITH IT!

During operation of the boiler, it is recommended to follow the precautions listed below:

- During operation of the boiler DO NOT approach or touch the door of the combustion chamber. There is a RISK OF BURNS.
- During operation of the boiler DO NOT approach or touch the flue pipe. There is a RISK OF BURNS.
- During operation of the boiler DO NOT perform any cleaning on the heating installation..
- During operation of the boiler DO NOT open the door of the firebox because it works properly only if the door is hermetically sealed.
- During operation of the boiler DO NOT clean the ashes.
- DO NOT allow children or animals to approach the pellet boilers.
- FOLLOW THE INSTRUCTIONS PROVIDED IN THIS DOCUMENT.

For the correct use of the boiler also follow the following advice:

- Only use the fuel recommended by the manufacturer of the boiler.
- Follow the instructions for maintenance.
- Clean the firebox after consumption of pellets in the pellet tank (3 to 14 days, only while the boiler and ashes in it are cold).
- DO NOT use a pellet boiler in case of system failure or other irregularities, unusual noises and/or if you suspect a malfunction. IMMEDIATELY contact an authorized service center.
- DO NOT pour water on the boiler and extinguish fire in the combustion chamber with water.
- DO NOT lean on the boiler because it may not be sufficiently stable and can be overturned.
- DO NOT use the pellet boiler as support or as a means of supporting other objects. Do not leave the lid of the pellet tank open.
- During operation, DO NOT touch the painted parts of the boiler.
- DO NOT use wood or coal in the pellet boiler, only use pellet of the following characteristics:
size: diameter: 6 mm
max. length: 30 mm
moisture content: up to 10%
firewood value: 16.9 MJ/kg, that is 4.7 kWh/kg
ash content: below 0.7%
- DO NOT use the boiler for burning waste.
- Always make sure you provide maximum safety.

7. INSTRUCTIONS FOR BOILER SAFE STARTING AND SAFE CLEANING

For starting the pellet boiler DO NOT in any case use heating oil, kerosene or similar derivatives and other flammable liquids. While the boiler is in operation, keep these liquids and other liquids away from it.

Make sure that the pellet boiler is properly installed and that it is not moving.

Make sure that the firebox is tightly closed and will remain closed during boiler operation.

Remove ashes only when the pellet boiler is cold.

Do not use abrasive cleaners for cleaning pellet boilers.

7.1. ROUTINE MAINTENANCE AND CLEANING

Using a vacuum cleaner to vacuum ashes facilitates the work of removing ashes from the boiler.

Before beginning any maintenance or a cleaning procedure, follow the following safety rules:

- Turn the pellet boiler off before beginning any procedure.
- Make sure that the boiler is cold before beginning any procedure on the boiler.

Vacuum the ashes deposited in the combustion chamber at least once every ten days, i.e. after consumption of pellets in the pellet tank (only while the boiler is cold) (**Figure 11**).

Vacuum and carefully clean the firebox at least once every ten days, i.e. after consumption of pellets in the pellet tank (only while the boiler is cold) (**Figure 11**).

Once a month, open the front bottom door of the heat exchanger on the right side of the boiler and vacuum the interior (**Figure 11**).

Always check if the boiler and ashes in it are cold.



Figure 10

This is a firebox for burning pellets (**Figure 10**). We recommend you inspect and remove the ashes from the bottom of the combustion chamber at every cleaning. Put the firebox into place and make sure that it is properly seated in its seating. This is the only way you can ensure that the boiler will work properly.



Figure 11

▲ CAUTION

Check that the sealing strip beneath the firebox is intact. If it is damaged, contact an authorized service.

For any further information, contact the installer. The manufacturer does not have direct control over the work of installers and cannot guarantee for any work done or for maintenance works.

The manufacturer does not in any case assume responsibility for damage caused by third parties.

▲ CAUTION

Make sure that the pellet boiler and ashes in it are cold.

Following the consumption of the entire tank of pellets the combustion chamber must be cleaned by vacuuming and/or removing all debris generated by pellet burning.

Incompletely burned pellets should never be returned to the pellet tank or disposed of in the container for ashes.

▲ CAUTION

WARNING

On a daily level, it is mandatory to open the door on the right before each ignition and thereupon shake the handle of the mechanism for chamber cleaning. This operation is of crucial importance in prevention of the ash-related tubes clogging and provision of safe and secure operation of the boiler.

▲ CAUTION

WARNING

Once in a fortnight it is mandatory to open the right door and clean the right ashtray where the ash is collected following the cleaning of the mechanism for chambers tube cleaning. The referred operation should be completed only when the boiler is cooled down.



7.2. INSPECTION AND PARTS THAT NEED TO BE MAINTAINED

CHECK THE ITEMS LISTED BELOW TO ENSURE PROPER OPERATION OF PELLET BOILERS. THESE PRECAUTIONS ENSURE THE MAXIMUM OUTPUT OF THE BOILER AND THE TEMPERATURE OF THE SYSTEM:

- ▲ Make sure that the pellet boiler and ashes in it are cold.**

- For a complete cleaning every week or after 200 kg of pellets have been consumed (whichever is earlier) the ashes underneath the firebox and from the combustion chamber must be vacuumed. You can use a brush to clean the walls of the firebox.

GENERAL CLEANING OF THE BOILER AT THE END OR BEGINNING OF THE HEATING PERIOD:

▲ Make sure that the boiler and ashes in it are cold. Turn off the power supply to the boiler.

- Upon completion of the heating period, disconnect the power supply to the boiler. It is very important to clean and inspect the boiler as described in this manual.

- The door seal may get detached after some time, although it is attached with glue resistant to high temperature. To reattach the seal apply an adhesive resistant to high temperature on the back side of the seal. In this way the sealing of the firebox door is guaranteed.

▲ CONNECTION OF THE FLUE PIPE TO THE CHIMNEY (should be cleaned at the end of each heating season).

Make sure that the pellet boiler and ashes in it are cold.

- The flue pipe, chimney and chimney cap should be inspected and cleaned annually. To carry out the procedure professionally, you should contact the chimney sweep.

7.3. ADDITIONAL MAINTENANCE

Your pellet boiler is a source of heat in which only pellet may be used. Annual maintenance of the boiler can only be performed by a person authorized by the Alfa Plam company a.d.

Regular annual service will preserve proper operation of the heating units, ensure their greater efficiency, keep the warranty valid and extend the life of the machine itself.

It is recommended to carry out the procedures described in the previous section at the end of the heating period. The purpose is to verify and ensure proper operation of all components.

8. IMPORTANT SAFETY INFORMATION

You have purchased the highest quality product.

The supplier is at your service for any information you may need. Proper installation of the boiler, carried out in accordance with the attached guidelines, is important for the prevention of any defect, risk or danger of fire.

The pellet boiler works on the basis of underpressure generated in the combustion chamber, therefore it should always be ensured that the joints to the chimney are sealed and tight.

▲ CAUTION

In the event the chimney catches fire, people and animals should immediately leave the residential area. Disconnect the power supply to the main switch immediately after that, or cut the plug out of the socket (only if you are not putting yourself at risk), and contact the fire department.

▲ CAUTION

For safety purposes and preservation of function of the pellet boiler, do not use finely chopped wood.

▲ CAUTION

Do not use the pellet boiler for incineration.

9. PELLET QUALITY IS VERY IMPORTANT

The pellet quality is very important!The stove is designed to use pellets. Since various types and dimensions of pellets appear on the market, it is important to choose pellets that do not contain impurities, and which are compact and do not produce dust (uses pellet which meets the European standard, minimum EN plus A2). Consult your supplier about the type of pellet, whose size must be 3,15-40 mm and cross section is 6 mm. **The proper functioning of the stove depends on the type and quality of the pellet.**

Under no circumstances shall the manufacturer be responsible for the poor operation of the stove due to the use of poor quality pellets.

▲ Attention

If sawdust or small – decomposed pellets are put into the funnel-shaped part of the stove i.e. the fuel tank, these may block the pellet feeding. Such pellets may obstruct the operation of the gear motor driving the pellet feeding mechanism, or they may damage the gear motor. If you see any such small, decomposed pellets at the bottom of the pellet tank or at the bottom of the screw conveyor when the tank is empty, vacuum them with the vacuum cleaner by inserting the vacuum cleaner hose through the openings of the pellet grate. Or even better, every one or one and a half months vacuum clean the tank bottom in the above described way when the tank has a little quantity of pellet.

9.1. PELLET STORAGE

Pellets must be stored in a dry place which is not too cold. Cold and wet pellets (with a temperature of around 5 °C) decrease the thermal power of the fuel and require additional stove cleaning.

▲ Attention

People with damaged spine and pregnant women should avoid raising pellet bags.

The manufacturer denies any responsibility for any damages or poor operation of the stove due to the use of poor quality pellets.

▲ Attention

The pellet must conform to DIN 51731, DIN plus, Ö-Norm M-7135 or other comparable European standards.

▲ Attention

THE PELLET MUST NOT BE KEPT NEAR THE STOVE. Keep them at least half a metre away from the stove.

When handling pellets, make sure that pellets do not spill.

If you pour the sawdust into the pellet tank, you may block the pellet loading system.

10. BOILER CONTROL SYSTEM

The boiler is equipped with advanced control system which provides a safe, efficient and reliable management of the operation and maximum functional efficiency of the boiler.

Characteristics:

- easy to install and use,
- easy and direct user functions,
- reliable and flexible functional software specifically developed for pellet boilers,
- advanced features available to installers in order to adapt different configurations and installations

10.1. Electrical connection diagram

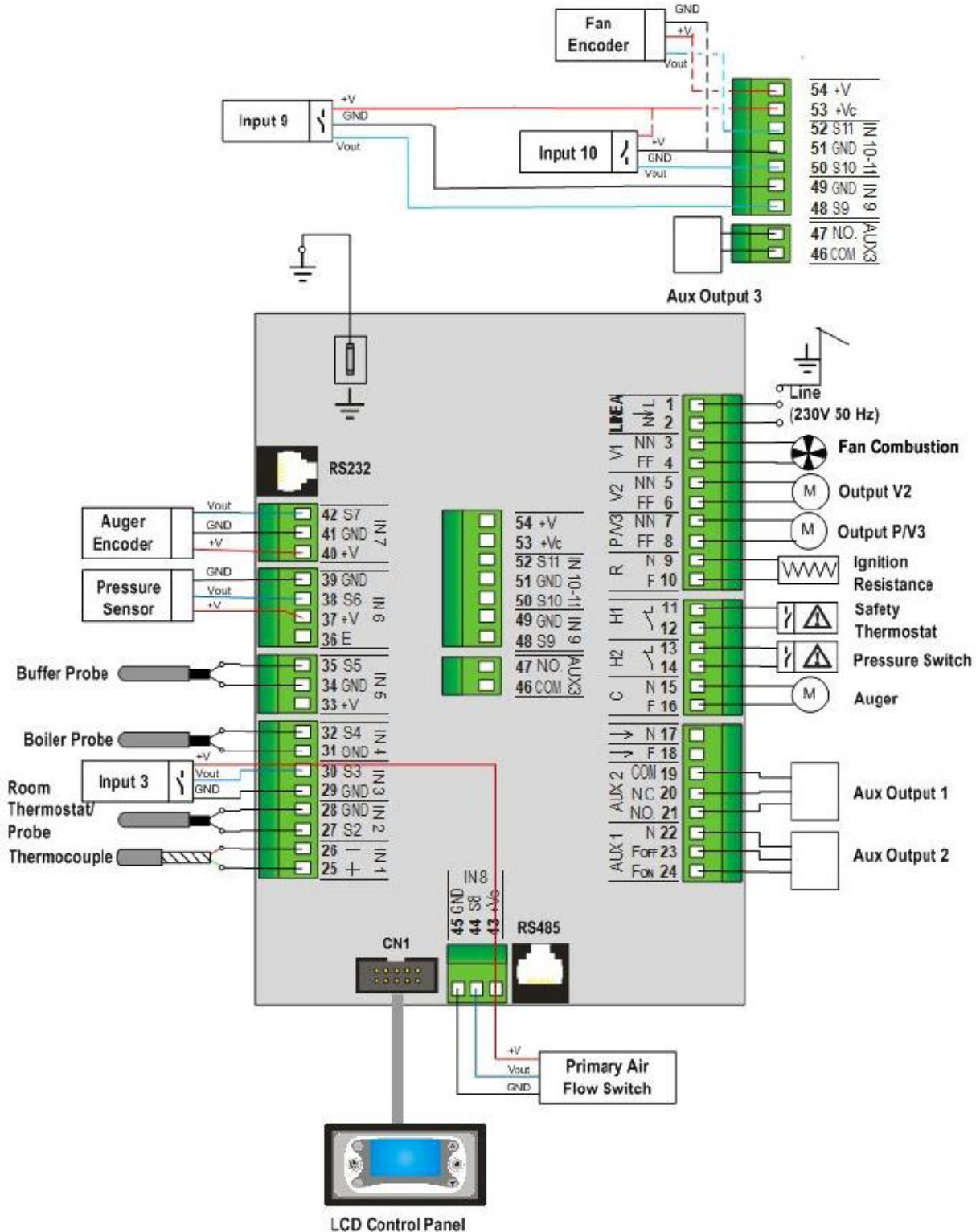

10.2. Control panel (display) – keys and functions

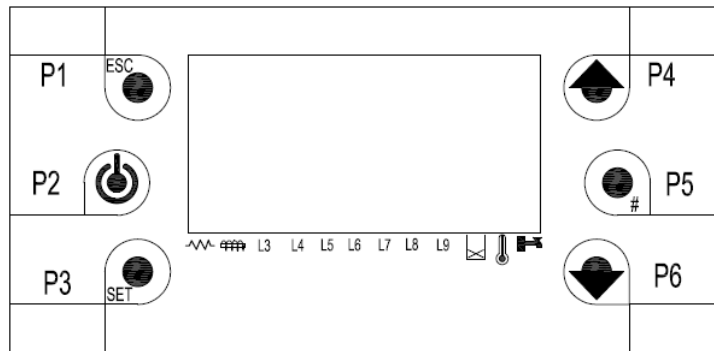

- Keys:**

Key	Function	Description
P2	On/Off	To ignite or extinguish boiler press and hold the key for 3 s after the acoustic sound
	Unblock	To Unblock the system when in Block Mode, press and hold the key for 3 s and longer after the acoustic sound.
P4	Change values	Change values and settings in menus and submenus
P6	Browse menus and sub - menus	Browse menus and submenus
	Visualization	Manage the visualization menu
P1	Esc	Exit menu or submenu
P3	Menu	Enter menu or submenu
	Modify	Manage change in menu
	Set	Save settings in menu
P5	Reset system maintenance 2 Function	Timer reset (only if this option is active)
	Manual Standby	Press and hold key for 3s to activate Standby mode

- LED symbols:**

Igniter	Led ON: Igniter is active	
Auger	Led ON: Auger is active	
Pump	Led ON: Pump is active	L3
Aux 1	Led ON: Aux 1 is active	L4
Additional motor	Led ON: Additional motor is active	L5
Aux 2	Led ON: Aux 2 is active	L6
Aux 3	Led ON: Aux 3 is active	L7
Not active		L8
Not active		L9
Pellet level sensor	Led ON: Out of pellet	
Exterior thermostat	Led ON: Contact is open	
Sanitary water switch	Led ON: Sanitary water required	

- Display:**

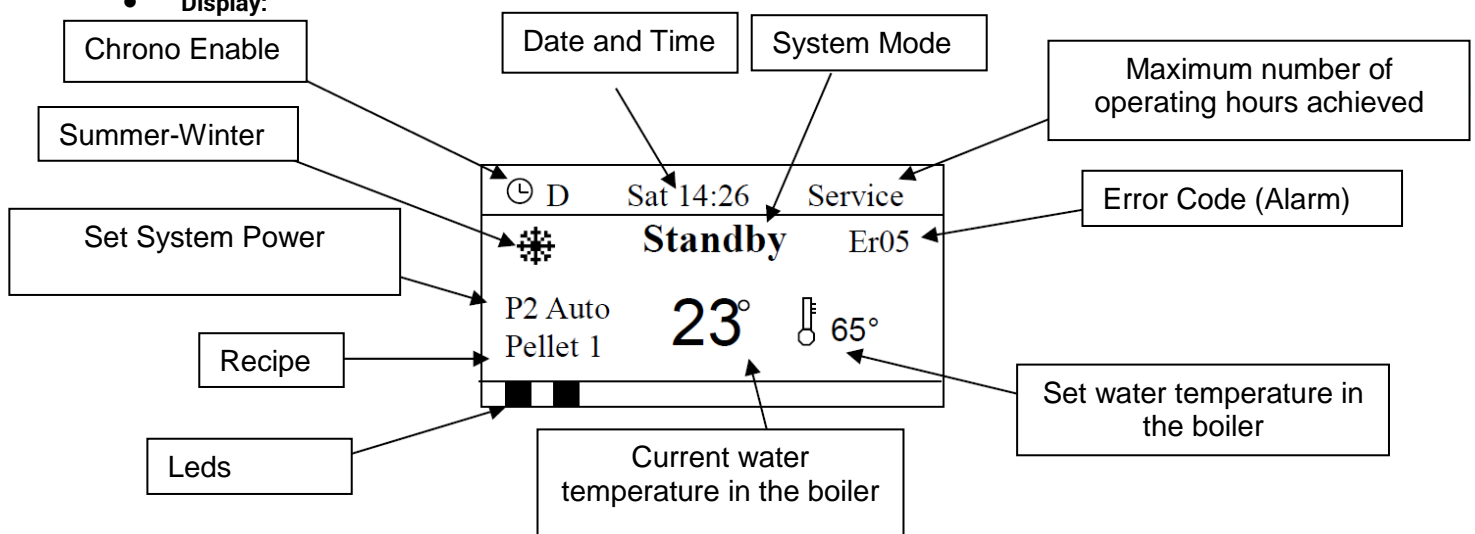

- Display:**

- Date and Time
- Chrono Modality (D-Daily, W-Weekly, We-Week-End)
- System Power (P1, P2, P3, P4 and P5)

- Recipe (Pellet 1)
- System Mode (Check Up, Ignition, Stabilization, Run Mode, Modulation, Standby, Safety, Extinguishing, Recover Ignition, Block, Off)
- **Errors (Alarms):**
If error (alarm) occurs, system switches to Block Mode.

Error Code (Alarm Code)	Error (Alarm) Description
Er01	Safety Thermostat Activated
Er02	Safety Manometer Activated
Er03	Extinguishing due to low temperature of flue gases
Er04	Extinguishing due to high water temperature in the boiler
Er05	Extinguishing due to high temperature of flue gases
Er06	Safety thermostat on auger housing is activated
Er07	Encoder error. No signal
Er08	Encoder error. Unable to adjust number of revolutions
Er09	Low water pressure
Er10	High water pressure
Er11	Error due to problems with the internal clock
Er12	Extinguishing due to ignition failure
Er15	Power outage longer than 50 minutes
Er16	Communication error RS485
Er17	Airflow regulator error
Er18	No pellet
Er25	Cleaning motor error
Er39	Airflow regulator broken
Er41	Minimum airflow in CHECK UP phase not reached
Er42	Maximum airflow reached
Er47	Auger encoder signal error
Er48	Unable to adjust the number of revolutions of auger motor
Er52	Module error I/O I2C

Other messages:

Sond	This message during Check-Up phase indicates that the temperature on one or more probes equals the minimum value (0°C) or maximum value (depending on the type of probe). Check that the probe is not open (0°C) or in short circuit (maximum value on temperature scale).
Service	This message indicates that the planned number of working hours has been reached and it is necessary to call the service.
Clean	This message indicates that the planned number of working hours has been reached and it is necessary to clean the boiler.
Block Ignition	This message appears if the system shuts down while in Ignition phase. The system will stop only when it switches to Run Mode.
Link Error	This message informs there is no communication between LCD display and the controller in the boiler.
Standby Man	Appears if the system is in Standby Mode due to pressed P5 key

- **Visualizations:**

By pressing keys P4 and P6 you enter the Visualization Menu. In this menu some values of system parameters can be seen.

L3 On P1 Pump	LED number and state of pump out
L4 Off Safety Valve	LED number and state of out Aux 1
L5 Off Out not used	LED number and state of additional motor out
L6 On Load Engine	LED number and state of out Aux 2
L7 Off Out not used	LED number and state of out Aux 3
Exhaust T.:103	Temperature of flue gases (°C)
Water T.: 55	Water temperature (°C)
Buffer T.: 52	*Buffer temperature (°C)
Room T.: 21	*Room temperature (°C)
Pressure: 1548	*Water pressure in the boiler (mbar)
Air Flux: 680	The flow rate of primary air (cm/s)
Speed Fan: 1000	Flue gases fan speed/voltage (rpm/V)
Auger ON: 800	Auger motor speed/voltage (rpm/V)
Product Code 448-0000	System Code
FSYD01000135.0.2	Controller firmvera version
PSYSF01000209.0.2	Display firmvera version

*In case the boiler configuration has no installed probes these values are not visible

10.3. Menu

The Menu consists of the User Menu and the Technical Menu.

The Technical Menu includes settings and adjustments which allow the manufacturer to modify parameters and system configuration. The Technical Menu is not available to user but only to the authorized representative of the manufacturer.

User Menu

By pressing **P3** key User Menu opens.

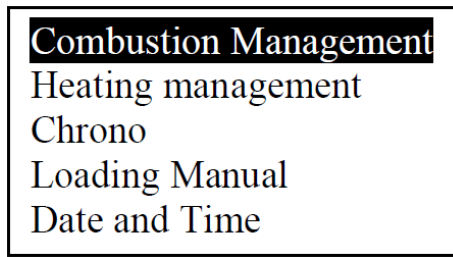

By pressing **P4** and **P6** keys choose the desired menu or sub - menu. Use **P3** key to open the desired menu or sub - menu.

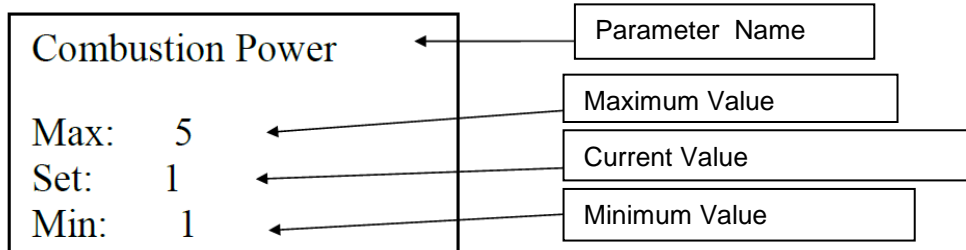

To increase or decrease parameter value press **P4** or **P6** keys. To save the new set parameter value press **P3** key. To cancel all modifications and return to previous values press **P1** key.

After change of parameter value the new value is transferred to main controller.

If the transfer was not successful, the following message appears on the display:

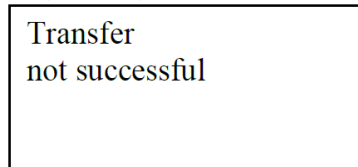

In this case, it is necessary to repeat the action.

The User Menu consists of multiple menus and sub - menus.

By pressing **P3** key the User Menu opens and the following list of sub - menus is visible:

Menu	Description
Combustion Management	The menu for the modification of combustion power, auger motor calibration and flue gases motor.
Heating Management	The menu for the modification of set value for water temperature in the boiler, buffer and other heating parameters.
Chrono	The menu for the Chrono program modalities and ignition/extinguishing times.
Manual Load	The menu for the manual auger loading. Possible only if the system is in OFF state.
Time and Date	The menu for setting the time and date.
Remote Control	The menu for activation of the remote control.
Language	The menu for change of the control panel language.
Keyboard Menu	The menu for setting the contrast and the light of LCD panel.
System Menu	The menu to access the technical adjustments.

10.3.1 Combustion Management Menu

This Menu provides modification of parameters determining combustion power. It consists of four sub - menus.

By pressing **P3** key the Menu opens and following sub - menus are visible:

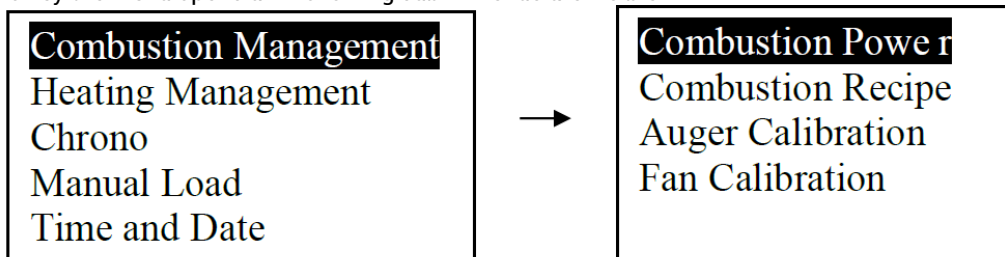

10.3.1.1 Combustion Power

This Menu provides combustion power management of the system in Manual or Automatic Mode (if option is available). In Manual Mode user can manage combustion power by himself.

Combustion	Description
1-5 (Combustion Power 1, 2, 3, 4 and 5)	Power is set manually by choosing Power 1, 2, 3, 4 or 5.
Auto (option not active)	Power is set automatically by the system

By pressing P3 key Combustion Power Menu opens.

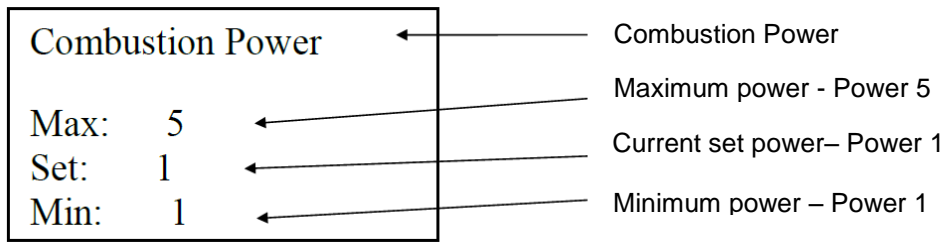

By pressing P4 and P6 keys choose the desired combustion power. To save the new set parameter value press **P3** key. To cancel all modifications and return to previous values press **P1** key.

10.3.1.2 Combustion recipe

This Menu provides combustion recipe management. In case there is only one recipe set as default this menu is not available.

10.3.1.3 Auger Calibration

This is the Menu for managing the feed rate of the auger. The system has 10 calibration steps (from -5 to +5; set default value is 0). The effect of calibration is valid in the operating mode and in modulation. For each step, the value is increased or decreased by 5%.

Example: Calibration value = -2; (-2*5%= -10%) This means that the calibration value of the auger speed will be decreased by 10% in relation to default value.

Default values	C03=600	C04=900	C05=1200	C06=1600	C07=2000	C11=600
Calibrated values	C03=540	C04=810	C05=1080	C06=1440	C07=1800	C11=540

10.3.1.4 Combustion Fan Calibration

This is the Menu for managing the number or revolutions of the combustion fan. The system has 10 calibration steps (from -5 to +5; set default value is 0). The effect of calibration is valid in the operating mode and in modulation. For each step, the value is increased or decreased by 5%.

Example: Calibration value = -3; (-3*5%= -15%) This means that the calibration value of the auger speed will be decreased by 15% in relation to default value.

Default values	U03=1000	U04=1200	U05=1400	U06=1600	U07=1800	U11=900
Calibrated values	U03=1150	U04=1380	U05=1610	U06=1840	U07=2070	U11=1030

Note: Do not calibrate the auger and the flue gases motor without previously consulting an authorized service representative or the manufacturer.

10.3.2 Heating Management Menu

This is the Menu for modification of parameters which determine the heating performance of the boiler. It consists of five sub - menus. By pressing P3 key the Menu opens and following sub – menus are visible:

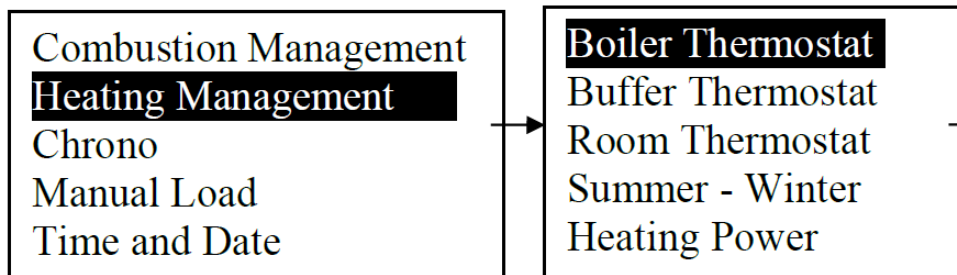

10.3.2.1 Boiler Thermostat

This is the Menu which allows management of set water temperature in the boiler. The water temperature in the boiler can be set between 30°C and 80°C. By setting the desired water temperature in the boiler the user conditions the boiler to operate on set power until the water temperature in the boiler reaches the set value. When the set water temperature in the boiler is reached, the boiler switches to Modulation Mode and continues to operate on minimum power.

We do not recommend setting the water temperature below 57°C due to possible condensation of the boiler, nor over 75°C.

10.3.2.2 Buffer Thermostat

This Menu allows the modification of buffer temperature. This Menu is active only if buffer is installed.

10.3.2.3 Room Thermostat

This Menu provides the modification of set room temperature. This Menu is visible only if the ambient probe or room thermostat options are activated.

10.3.2.4 Summer – Winter

This Menu provides the modification of the boiler functionality depending on the season. The screen displays one of two symbols: ❄️ or ☀️.

10.3.2.5 Heating Power

This Menu is not active.

10.3.2.6 Remote Keyboard

This Menu allows management by Remote Keyboard. First it must be activated by previous setting of certain parameter.

10.3.3 Chrono Menu

This is the Menu for setting the time of system start up/shut down and programming stove operation for specific time periods.

Contains two sub - menus:

- Modality
- Chrono program

10.3.3.1 Modality

- By opening the Chrono Menu two sub – menus are visible Modality and Programming.
- By pressing P4 and P6 keys choose one of sub – menus and open it by pressing P3 key. The Modality Menu contains the following list:

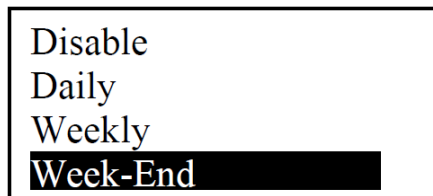

- The description of settings in the Modality Menu:

Description	Keys	Display
Current modality blinks		
Entering change mode	P3	
Select the desired modality	P4 and P6	
Cancelation of change and return to previous modality	P1	
Save changes	P3	
Exit the Menu	P1	

10.3.3.2 Chrono program

By opening the Chrono Menu two sub – menus are visible: Modality and Programming.

By pressing P4 and P6 keys choose one of sub – menus and open it by pressing P3 key. The Chrono Program Menu contains the following list:

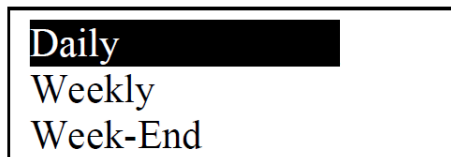

The description of settings in the Chrono Program Menu:

Program selection	Keys	Display
Current program blinks		
Entering sub - menu	P3	
Select the desired program	P4 and P6	
Exit the Menu	P1	

There are three separated types of programming. For example, if the Daily program is activated, the other programs remain unchanged. **After completing the programming it is necessary to select the desired modality in the Modality Menu to allow start up/shut down of the system for set time periods.**

The description of setting the desired program in the Chrono Menu:

HRONO PROGRAM	Keys
After selection of the desired program, choose time period for startup /shut down	P4 or P6
Enter selection mode (selected time blinks)	P3
Change the time	P4 or P6
Save changes	P3
Program start up (↵ appears) or program shut down (↵ disappears)	P5
Exit	P1

There are three types of programs that can be set:

- Daily Program – select the day of the week and programmed time of system start up and shut down. There are three time intervals for each day.

Daily	Monday	Monday
Weekly	Tuesday	ON OFF
Week-End	Wednesday	09:30 11:15 √
	Thursday	00:00 00:00
	Friday	00:00 00:00

- Weekly Program – programming system start up/shut down time for the whole week. There are three time intervals available.

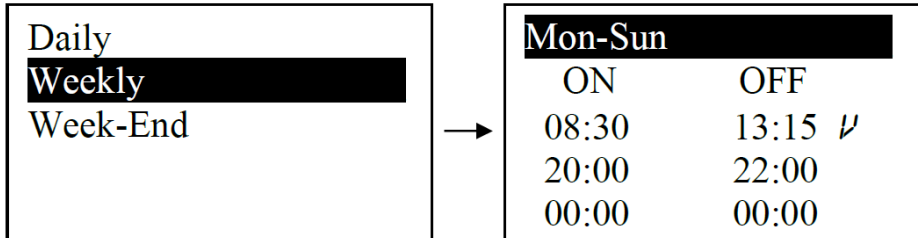

- Week-End Program – select between two periods "Monday – Friday" and "Saturday – Sunday". There are three time intervals for both periods.

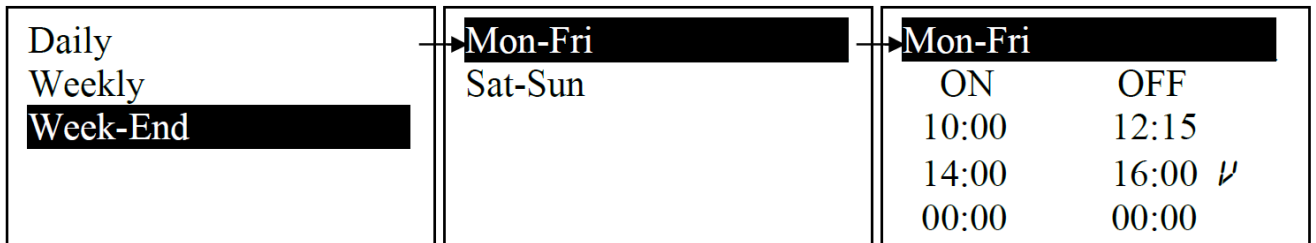

10.3.4 Load Menu

This menu enables manual pellet dosing. In order to perform manual load, the boiler must be in OFF state

10.3.5 Time and Date Menu

This Menu allows setting of correct time and date.

Hours, minutes, year, month and date can be set by pressing P4 and P6 keys.

Select the change mode by pressing P3 key. Change the value by pressing P4 and P6 keys.

Save changes by pressing P3 key and exit the Menu by pressing P1 key.

10.3.6 Remote Control Menu

This Menu allows the activation or deactivation of the Remote Control SYTX. The manufacturer did not include the Remote Control option.

10.3.7 Language Selection Menu

This Menu allows language change on LCD display.

10.3.8 Keyboard Menu

Consists of two sub - menus:

Menu	Description
Set contrast	Menu for setting the LCD display contrast
Set Minimum Light	Menu for setting the LCD display light

10.3.8.1 Set Contrast

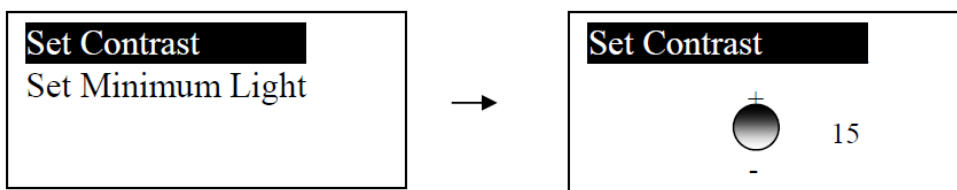

By pressing P4 and P6 keys increase or decrease contrast.

By pressing P3 key save changes and exit the menu.

By pressing P1 key exit the menu without saving changes.

10.3.8.2 Set Minimum Light

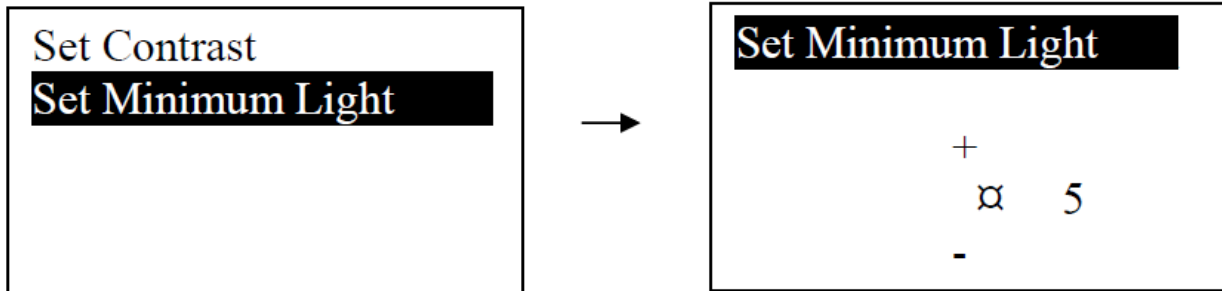

By pressing P4 and P6 keys increase or decrease (min 0, max 20).

By pressing P3 key save changes and exit the menu.

By pressing P1 key exit the menu without saving changes.

10.3.9 System Menu

This Menu provides access to technical settings. Access is password protected and allowed only to authorized technical personnel.

10.4. Ignition of the boiler and Ignition Phases

Press P2 key and hold it for 3 s or longer to start up the boiler. Following ignition phases are:

Check Up Phase
During Check Up Phase initial test of correctness on boiler input signal, probes and manometers is performed. During this phase flue gases motor is working at maximum speed while auger and igniter are turned off. Check Up Phase takes a few seconds and after a successful test Ignition Phase starts.
Ignition Phase
Ignition Phase is comprised of four consecutive sub - phases: <ul style="list-style-type: none">- Preheating Phase- Preload Phase- Ignition – Fixed Phase- Ignition – Variable Phase During the Ignition Phase IGNITION is visible on display. There are no special signs for sub - phases on the display.
Ignition Preheating Phase
During this phase the igniter is being warmed up before the pellet dosing starts. In order to achieve a successful pellet ignition it is preferred that the igniter is already warmed up at the time the pellet dosing starts. In this phase the igniter is active and the auger inactive. Flue gases motor is working at lower speed to boost the igniter warm up.
Ignition Preload Phase
During this phase the initial pellet dosing starts and the auger supplies the required amount of pellet for ignition. During this phase the igniter, auger and flue gases motor are active.
Ignition – Fixed Phase
This phase lasts a fixed time period of 180 seconds. In case the ignition was successful before this phase ended it will continue until the time frame expires and the stove switches to stabilization phase. During this phase the igniter, auger and flue gases motor are active.
Ignition – Variable Phase
This phase follows a fixed phase. The duration of this phase varies. It starts with fulfillment of the conditions for ignition until the temperature of flue gases is 45°C. In case the ignition of the boiler is achieved before the phase time expires the phase is interrupted and Stabilization Phase starts. During this phase the igniter, auger and flue gases motor are active.
Stabilization Phase
Stabilization Phase is a transitional state between Ignition Phase and Run Mode Phase. This phase starts with fulfillment of the conditions for ignition or when flue gases reach the temperature of 45°C. It lasts three minutes and during that time the igniter, auger and flue gases motor are active.
Run Mode Phase
Run Mode Phase starts after Stabilization Phase. There are five levels of power which can be set during this phase (see 10.3.1.1). During this phase the igniter is inactive while the auger, flue gases motor and pump are active and operate at different intensity depending on the power level set. The boiler is operating at the set power until modulation conditions are achieved.
Modulation Phase
The boiler switches to Modulation Phase when one of two conditions is achieved: <ol style="list-style-type: none">1. When boiler achieves set water temperature2. If flue gases temperature reaches the temperature higher than 200°C During Modulation Phase the boiler is operating with minimum power – power 1 until the temperature decreases below the set value.

Standby Mode
The boiler switches to Standby Mode when one of two conditions is achieved: 1. When the boiler reaches the set water temperature it switches to modulation and continues to increase temperature of water by inertia to the value of 4°C higher than the set water temperature in the boiler. 2. When exterior (room) thermostat reacts During Standby Mode pellet dosing stops and the boiler is switching off. The boiler switches on again when the water temperature is 4°C lower than the set value or when the room thermostat deactivates.
Safety Mode
Safety Mode occurs when the flue gases temperature exceeds 230°C or when water temperature in the boiler reaches 85°C. During this phase pellet dosing stops until the flue gases temperature is beneath 230°C or the water temperature in the boiler is beneath 85°C. If there is no temperature reduction in the next 60 seconds the boiler switches to Alarm Mode and displays a message Er04 or Er05 .
Extinguishing Phase
The boiler is switched off by holding P2 key for 3 s and longer. The Extinguishing Phase starts during which pellet dosing stops while the flue gases motor and pump operate at maximum capacity to cool down the boiler as soon as possible. The minimum duration of the Extinguishing Phase is 300 seconds and the condition for complete shutdown of the stove is that the flue gases temperature is below 70°C.
OFF
The boiler is switched off in this mode (the flue gases motor, the pump, the igniter and the auger are not active).
Block Mode
The Block Mode occurs in case of error or alarm. During Block Mode the flue gases fan, auger and igniter are switched off. To exit press and hold P2 key for 3 seconds: If the blockade is overcome and nothing causes the alarm, the system will shut down.
Recover Ignition
The boiler switches to this phase in two cases: 1. If a power failure occurs in the operation mode and the flue gases temperature is higher than 45°C. 2. Pressing the main power switch while stove is in Extinguishing Phase.

10.5. Possible problems and solutions

Display message	Description	Possible causes	Resetting errors	Possible alarm solutions
Er01	Safety thermostat activation	High water temperature in the boiler	Wait until the boiler is completely cool and then unscrew the plastic cap on the thermostat and press the reset button	Check the validity and functionality of the pump
		Faulty or poorly connected pump		Contact service
		Faulty thermostat		
Er02	Safety manometer activation	Obstruction of flue gases	Press and hold P2 key longer than 3 seconds	Check soiling of flue pipes and chimney
		Incorrect chimney installation		Contact service
		Faulty manometer		
Er03	Shutting down due to the low flue gases temperature	Poor combustion (too much or too little of pellet remains in the combustion chamber)	Allow the boiler to shut down and then press and hold P2 key longer than 3 seconds	Check the size of pellet granules
		Pellet tank empty		Check soiling of furnace chamber
		Faulty flue gases probe		Check condition of flue pipes
Er05	Shutting down due to the high flue gases temperature	The flue gases temperature exceeds the limit	Allow the boiler to shut down and then press and hold P2 key longer than 3 seconds	Contact service
		Obstruction of flue gas pipes		Check soiling of flue gas pipes and chimney
		Faulty flue gas probe		
Er07	Encoder error	Encoder signal missing	Allow the boiler to shut down and then press and hold P2 key longer than 3 seconds	Contact service
Er08	Encoder error	The flue gas motor is not reacting	Allow the boiler to shut down and then press and hold P2 key longer than 3 seconds	Contact service
		The flue gas motor is working faster or slower than set		

Er11	Clock error	Problems with the internal clock	Press and hold P2 key longer than 3 seconds	Check the accuracy of set time set
		Insufficient capacity of internal battery		Check the correctness of programming in Chrono mode
Er12	Boiler ignition failure	Boiler ignition error	Allow the boiler to shut down and then press and hold P2 key longer than 3 seconds	Check the condition and quality of used pellet
		During Ignition Phase the adequate flue gases temperature has not been achieved		Check soiling and draft of flue gas pipes and chimney
		Faulty flue gas probe		Contact service
Er15	Power outage	Power outage during boiler operation	Press and hold P2 key longer than 3 seconds	Check system and installation Contact service
Er16	Communication error between electronics and display	Display cable interruption	Press and hold P2 key longer than 3 seconds	Check display cables and connectors
		Damage to the display cable connectors		Contact service
Er17	The primary air flowmeter error	The primary air flowmeter is not adjusting the boiler operation	The boiler continues to operate without primary air adjustment. To reactivate the primary air flowmeter shut down the stove. Allow the boiler to shut down and then press and hold P2 key longer than 3 seconds	Check soiling of primary air opening and pipes
				Check soiling and draft of flue gas pipes and chimney
Er39	The primary air flowmeter sensor is damaged	Faulty sensor	The boiler continues to operate without primary air adjustment	Contact service
Er41	Minimal primary air flow not reached during the validation phase	An obstacle or major soiling of the primary air pipe	Allow the boiler to shut down and then press and hold P2 key longer than 3 seconds	Check and clean primary air inflow pipes
		Obstruction of flue gas pipes		Check soiling and draft of flue gas pipes and chimney
		Inadequately closed door during the ignition phase		Check if the chamber door close correctly Contact service
Er42	Primary airflow is greater than the maximal allowable value	Excessive amount of air inflow	Allow the boiler to shut down and then press and hold P2 key longer than 3 seconds	Check the pipe for primary air inflow
				Check soiling and draft of flue gas pipes and chimney
				Contact service

Attention: If the recommended solution fails to remove the direct cause of the alarm CONTACT ALFA PLAM CALL CENTER or the closest authorized service

11. INFORMATION ON THE DISPOSAL AND STORAGE OF THE BOILER

Disposal of the boiler and its removal (as waste material) is under the responsibility of the owner of the boiler.

The owner must comply with the applicable regulations of the state where the boiler is disposed, for sake of safety and environmental protection.

Disposal of the boiler can be delegated to a third party that is licensed for such work.

INDICATION: In any case, you have to respect the laws of the state in which the pellet boiler is installed.



WARNING: All disassembled parts that should be destroyed must be properly removed:

- remove all electrical components
- disconnect the battery from the electronics
- dispose of the battery separate from the electronics in accordance with the standards in designated containers
- separate the base of the boiler and dispose of it as a scrap



WARNING: Boilers thrown in outside in natural environment is becoming a serious threat to humans as well as animals.

When the boiler is disposed, it is necessary to dispose of CE marking, instructions for use and any other document related to the installation.

12. TECHNICAL CHARACTERISTICS OF THE GRANDE - PELLET BOILER

Name of characteristic	Value	
	Minimum	Nominal
Boiler power (kW)	7,86	27,9
Efficiency (%)	91,68	90,82
Consumption of pellets per hour kg/h	1,8	6,47
CO emission (at 10% O ₂) (mg/m ³)	481	86
Flue uptake connection (mm)	Ø80	
Weight (kg)	310 - 345	
Fuel	pelet	
Pellet tank (kg)	~ 200	
Chimney draft (Pa)	11,5 (± 2)	
Power supply (V)	220-230	
Frequency (Hz)	50	
Largest power consumption during operation of the boiler (W)	53	
Largest electricity consumption when starting the boiler (W)	324	
Average smoke temperature (°C)	111	
Mean value of NO _x at 10% O ₂ at nominal power (mg/m ³)	194	
Mean value of C _{OGC} at 10% at 10% O ₂ at nominal power (mg/m ³)	19,45	
Mean value of dust emission at 10% O ₂ at nominal power (mg/m ³)	38,5	
Flue gas mass (g/s)	17,18	
Maximum working pressure of water (bar)	2	
Maximum working temperature of water (°C)	80	
Capacity of the boiler (l)	74	

13. DIMENSIONS OF BOILER - GRANDE

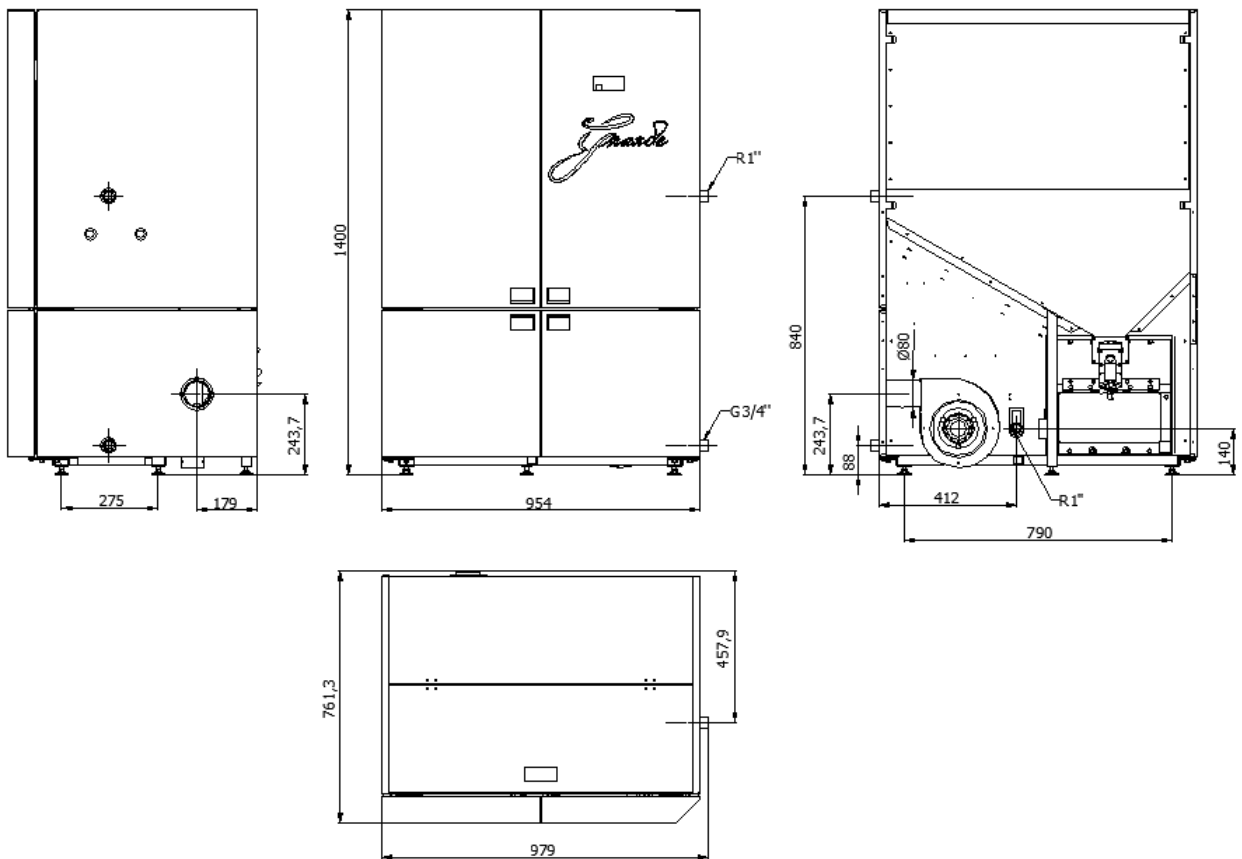
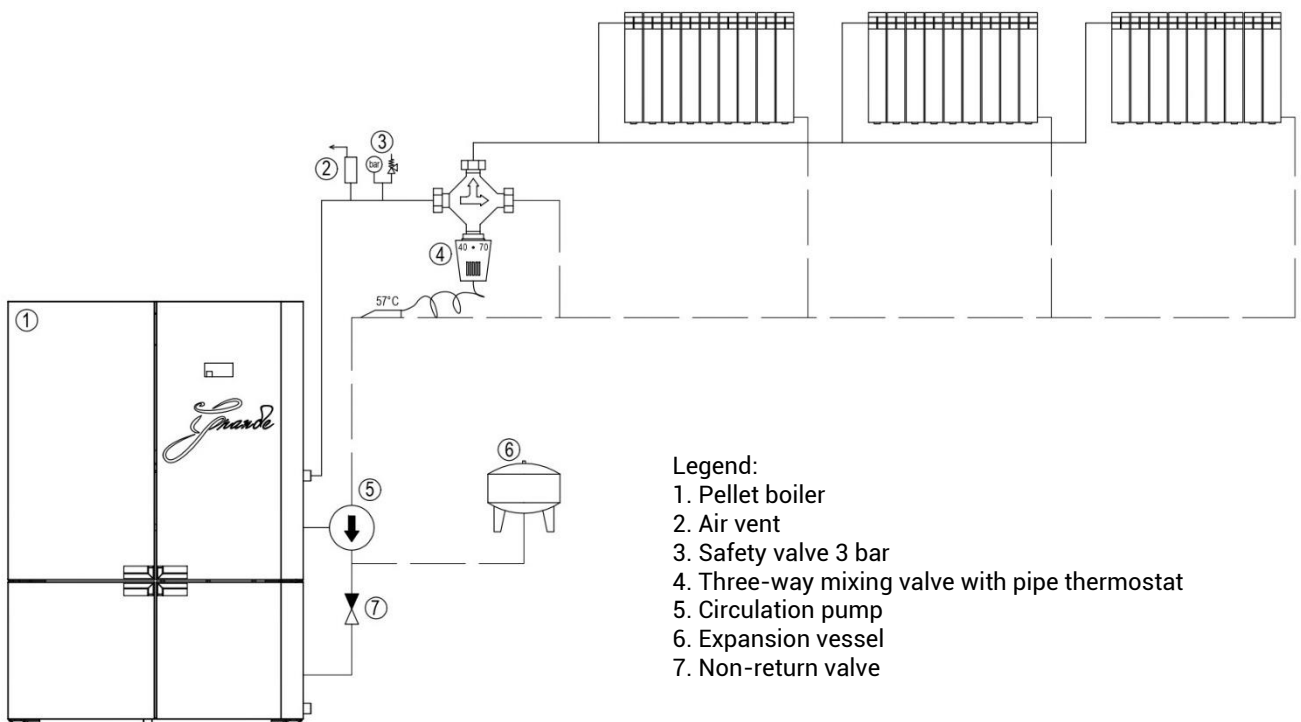

Figure 15

14. Scheme of hydraulic installation of pellet boiler – GRANDE

In order to reduce the risk of condensation, install a three-way mixing valve with a pipe thermostat when installing the boiler.

14.1. Pellet boiler hydraulic installation diagram (radiator heating)



14.2. Pellet boiler hydraulic installation diagram (radiator and floor heating)

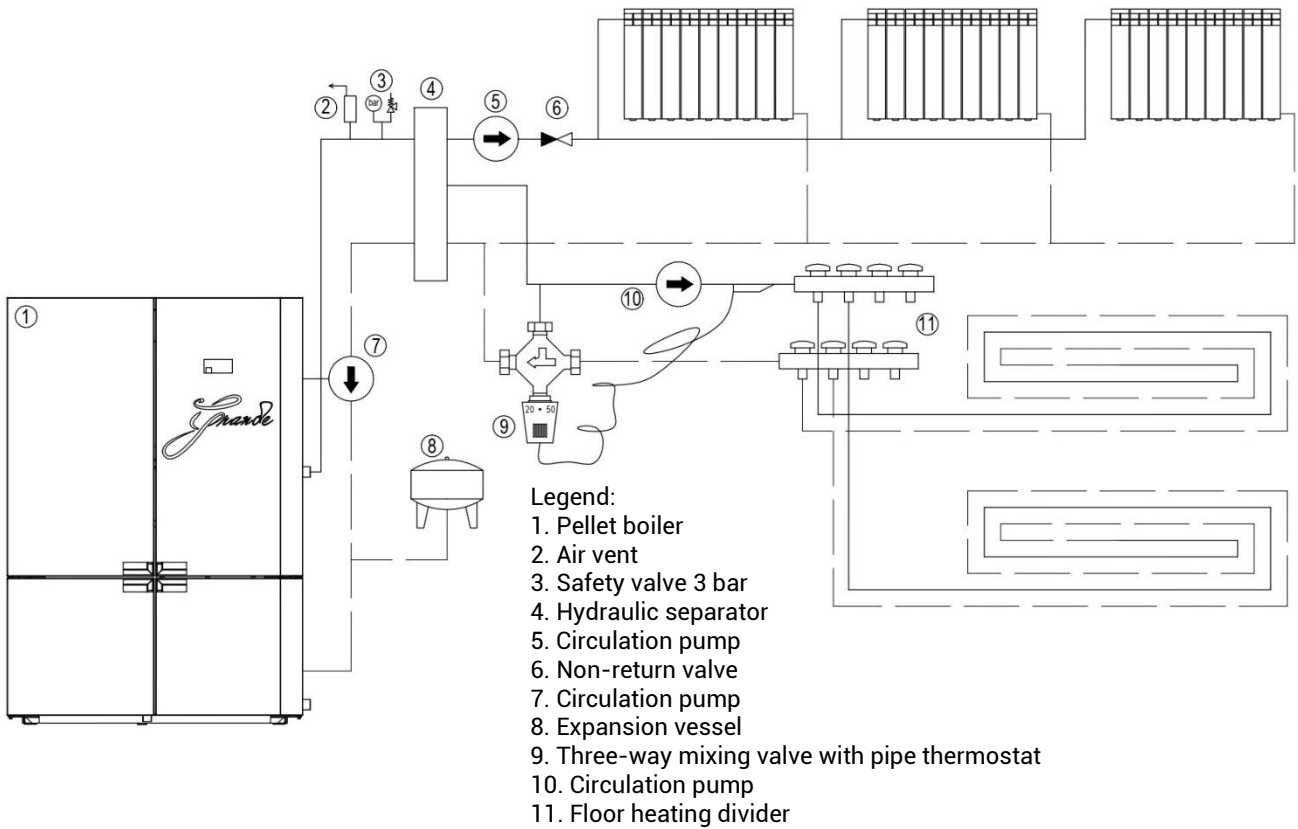

Note: If only floor heating is connected to the boiler, make sure to install an accumulation tank (BUFFER).

14.3. Pellet boiler hydraulic installation diagram (accumulation tank)

